



**FOR ENDORSEMENT
AND FORWARDING**

PUBLIC

CLOSED SESSION

TO: Executive Committee

SPONSOR: Scott Mabury, Vice President, Operations and Real Estate Partnerships

CONTACT INFO: 416-978-2031, scott.mabury@utoronto.ca

PRESENTER: Scott Mabury, Vice President, Operations and Real Estate Partnerships

CONTACT INFO: 416-978-2031, scott.mabury@utoronto.ca

DATE: October 8, 2019 for October 15, 2019

AGENDA ITEM: 4(d.)

ITEM IDENTIFICATION:

Capital Project: King's College Circle Geothermal Project

JURISDICTIONAL INFORMATION:

Pursuant to section 4.2.3. of the Terms of Reference of the Planning and Budget Committee, "...the Committee considers reports of project planning committees and recommends to the Academic Board approval in principle of projects (i.e. space plan, site, overall cost and sources of funds)."

Under the *Policy on Capital Planning and Capital Projects*, "...proposals for capital projects exceeding \$20 million must be considered by the appropriate Boards and Committees of Governing Council on the joint recommendation of the Vice-President and Provost and the Vice-President, University Operations. Normally, they will require approval of the Governing Council. Execution of such projects is approved by the Business Board. [...] If the project will require financing as part of the funding, the project proposal must be considered by the Business Board."

GOVERNANCE PATH:

A. Project Approval

1. Planning and Budget [for recommendation] (September 17, 2019)
2. Academic Board [for recommendation] (October 3, 2019)
3. Business Board [for approval, financing] (October 7, 2019)
4. **Executive Committee [for endorsement and forwarding] (October 15, 2019)**
5. Governing Council [for approval] (October 24, 2019)

B. Execution of the Project:

1. Business Board [for approval] (October 7, 2019)

PREVIOUS ACTION TAKEN:

The Landscape of Landmark Quality project presented a unique opportunity to develop a geexchange system underneath the Front Campus at King's College Circle. As a result, the University engaged a consultant to study the feasibility of installing a geothermal system of this size and scale. The feasibility study described a project that would allow the University to simultaneously offset a significant amount of the carbon produced and address deferred maintenance in several existing buildings.

On November 30, 2018, the CaPS Executive Committee approved funding requested to proceed with hiring consultants required to carry the project through Construction Documents.

HIGHLIGHTS:

University of Toronto's Carbon Reduction Commitment

The University of Toronto has joined 12 other leading research universities in North America in a coalition to reduce greenhouse gas emissions on their own campuses and in their communities. Members of the University Climate Change Coalition aim to mobilize their resources, research partnerships and expertise to help businesses, cities and regions implement research-driven climate solutions. As part of the coalition, U of T has set a goal to reduce greenhouse gas emissions by thirty-seven (37) % from 1990 levels by the year 2030. The University is also developing programming to engage the Toronto area community in sustainability.

In recent years, U of T has made great strides in reducing its carbon footprint across its three campuses, reducing its energy and water usage through various retrofits and sustainability initiatives. For example, despite a 26 per cent growth in floor space and a fifty (50) % increase in the number of students, U of T lowered its total greenhouse gas emissions by thirty-two (32) % from 2008 to 2016. Further to this, in 2018 U of T was named one of Canada's greenest employers – for the fifth time.

U of T has a carbon target of approximately 59,000 tonnes per year by 2030, which would represent a need to reduce our emissions by seventy (70) % from 2017. The bulk of the required reductions, and opportunities, are to be found at St. George Campus which represents ~ninety (90) % of the total for U of T.

In an effort towards this target, U of T, has launched a series of greenhouse gas reduction projects. These projects were partially funded through the Ontario Government's cap and trade program and include:

- Introduction of DDC building controls in a number of campus buildings currently equipped with legacy systems or having no automation system at all,
- Installation of primary and sub-metering on all buildings currently without this technology on campus,
- Installation of renewable systems which marry photovoltaic electrical producing arrays with solar thermal array systems, producing electricity and hot water simultaneously,
- Upgrade of our aged chilled water infrastructure with energy efficient equipment.

These projects are part of the over \$50-million in investments and are projected to reduce our greenhouse gas emissions by 8,000 tonnes of CO₂ annually, starting in 2019.

King's College Circle Geothermal Project

The University has an excellent track record of reducing utility consumption and GHGs through the execution of hundreds of water and energy reducing projects over the past decade. As part of our continued effort, and in support of our carbon commitment, U of T has conducted a feasibility study into geothermal applications on Front Campus.

Geothermal as a general concept is the process of using the earth to generate or store energy for use in either power generation or direct supply of energy. At the commercial and institutional level, the type of geothermal system that will be most commonly seen is a geo-exchange type system, which utilizes the thermal properties of the soil to store energy for later use. The earth, at depths of around six meters or more becomes very consistent in its temperature. The seasonal effects of air temperature for traditional systems become greatly reduced, and temperature variances in geothermal systems become minimal year-round. The property of the temperature being shielded from environmental conditions allows us to use the earth as a thermal 'battery' where we can dump and extract heat as required to serve building HVAC needs.

The proposed system will incorporate deep boreholes underneath the parking structure of the landmark project, and is slated to be Canada's largest geothermal system in an urban setting. This system can be considered a high temperature hybrid geothermal system, expanding on the thermal storage capabilities of geothermal systems, while reducing the reliance on heat pumps. This option achieves its efficiency by increasing the annual utilization rate of the system (more uptime results in a shorter payback) by storing heat at a higher temperature, and directly feeding the ground source water into the low temperature hot water loop at 140°F.

The goals of this option are to:

- Store reject/excess thermal energy from the summer for use in the winter,
- Provide heating water at or above 140°F, for heating buildings in and around King's College Circle,
- Retrofit MSB and other buildings to accept geothermal heating supply temperatures,
- Provide snow melting for pedestrian walkways around King's College Circle,
- Maintain focus on heating loads to maximize carbon footprint reductions.

The major differentiating factor between this option and more conventional ground source heat pump options is the focus on thermal energy storage, while coupling with the waste heat generated by our cogeneration turbine. To increase the ground temperature, there will have to be some revisions to how waste heat is handled – both from heat rejected during cooling and from the Sofame, as well as the supply of heat energy to the geothermal field. At present, there is an excess amount of heat produced by the cogeneration system in the summer months and available through the low temperature loop. This reject heat from our co-generation system can be used to increase ground temperature, and provide additional heating capacity in the winter. As such, we can heat more buildings with what is in essence a zero incremental carbon source.

Schedule

The proposed schedule for the project is as follows:

- | | |
|---|-------------------------|
| • CaPS Executive approval (Consultant fees) | Dec 18, 2014 |
| • Consultant Selection (Competition) | June - September 2015 |
| • Letter of Award | December 2015 |
| • Schematic Design | January – December 2016 |
| • CaPS Executive approval (Consultant fee increase) | August 28, 2017 |
| • Design Development | June 2017-March 2019 |
| • CaPS Executive approval (Consultant fee increase) | March 8, 2019 |
| • Municipal Approvals (SPA submission) | March 21, 2019 |
| • Cycle 1 Governance (CaPS Executive) | August 23, 2019 |
| • Cycle 1 Governing Council approval | October 24, 2019 |
| • Construction Documents | May to December 2020 |
| • Tender and award | January 2020 |
| • Mobilization and Construction start | Spring 2020 |
| • Full operational occupancy | End of 2023 |

FINANCIAL AND PLANNING IMPLICATIONS:

The University will be launching a campaign to promote this project in the Fall of 2019. Further to this, the project has been submitted to various funding programs at the provincial and federal level.

Discussion of overall costs and sources of funds can be found in the *in camera* document for this project.

RECOMMENDATION:

Be It Resolved

THAT the following recommendation be endorsed and forwarded to the Governing Council

THAT the *King's College Circle Geothermal Feasibility Report*, dated September 21, 2018, be approved in principle; to be funded by financing and Central Utility Funding.

DOCUMENTATION PROVIDED:

- *King's College Circle Geothermal Feasibility Report*, dated September 21, 2018



MORRISON HERSHFIELD

Final Report

University of Toronto

**Landscape of Landmark Quality -
King's College Circle Geothermal
Feasibility Report**

Toronto, Ontario

Presented to:

Jacquanline Liu

Project Manager, University Planning Design &
Construction

University of Toronto

255 McCaul Street
Toronto, ON
M5T 1W7

University Project Number: P888-15-065

MH Project Number: 1803671 September 21, 2018

P:\2018\180367100-LANDSCAPE OF LANDMARK QUALITY-GEOTH08.
WORKING\FINAL\UOFT LANDMARK GEOTHERMAL FINAL REPORT.DOCX

TABLE OF CONTENTS

	Page
1. EXECUTIVE SUMMARY	1
2. INTRODUCTION	3
2.1 Objectives	3
2.2 Reference Documents	3
2.3 Limitations	3
2.4 Opinions and Probable Cost	4
2.5 Methodology	4
3. BACKGROUND ON GEOTHERMAL SYSTEMS	6
3.1 Geothermal System Operations and Installation	6
3.2 Existing Geothermal System Installations	9
4. LANDSCAPE OF LANDMARK QUALITY PROJECT	11
4.1 University Site Background	11
4.2 Heat Trace Expansion Project	11
5. GEOTHERMAL AT UOFT	13
5.1 Benefits of Geothermal for Snow Melt	13
5.2 Proposed Geothermal Options	13
6. ADDITIONAL INFORMATION	21
6.1 Next Steps and Design Coordination	21
6.2 High Lift Heat Pump Technologies	21
6.3 Phase Change Thermal Storage	22
6.4 Medical Sciences Building Heating Load	22
6.5 Connection to Existing Services	22
7. CONCLUSION	24

APPENDIX A: Drawings

APPENDIX B: Preliminary Proposed Options



1. EXECUTIVE SUMMARY

Morrison Hershfield Limited (MH) was retained by The University of Toronto (UofT) in May, 2018 to study the feasibility of a geothermal system installation located beneath King's College Circle at the St. George campus. The below represents the final report submission for the University of Toronto's consideration.

A brief background and history on geothermal systems was discussed in Section 3 below. For the application at the University of Toronto Campus, a Heat-Injected Vertical-Borehole-Field with a Heat Pump system that is (partially) Ground Coupled is proposed to be installed. Descriptions were included for both Balanced Geothermal Systems, as well as Hybrid systems to provide further information on the operation of the further stated options.

The Landscape of Landmark Quality project was briefly reviewed in Section 4 below. It was noted that the snow melt system proposed by a third party consultant in their 100% Design Development Drawings will require 18,645MBH of peak demand. We estimate that this will translate to 13,620 mmBTU of heat annually. During the idle operation of the snow melting system, geothermal heating is a great candidate due to the lower temperatures that are required. Possible construction concerns of the geothermal system and Parking Garage were discussed in this section as well. Ultimately there is nothing that will stop a geothermal system from being feasible, but it is agreed that coordination efforts will have to take place between the geothermal designers and Parking Garage designers.

Finally, in Section 5, two different options are proposed which demonstrate what we believe to be the most economical and beneficial for a geothermal installation at the University of Toronto. The options proposed are the conclusions of an iterative process that involved multiple discussions with the University of Toronto. For a summary of previous options that have been proposed, please refer to Appendix B. Note that these Options are still technically viable, but are not suited for the current University energy costs and utility rates. All options proposed in this report, and in previous reports/presentations, operate on similar principles, and system operation can be manipulated to allow the same geothermal field to function in any of the discussed ways. A robust design has been carried out in all options to allow for this flexibility over the next 100+ years.

Of the two options provided in this report, both are a hybrid geothermal system that rely on the injection of heat from the campus Flue Gas Heat Recovery system to maintain high ground temperatures, and reduce reliance on heat pumps to generate 140°F water. Included within the cost estimates of these options is the geothermal borehole field, mechanical equipment, and connection to services in the parking garage (tunnel connection to existing site services has not been allowed for). It is assumed that as part of the Landmark Parking Garage project, that a 375m² mechanical room shell will be provided.

Option three involves the installation of 311 boreholes at 600' deep, and a horizontal piping system. The system is capable of producing 12,900 MBH of heating year round, totaling 113,000 mmBTU of heating energy annually. The capital cost investment is \$6,161,600 (\$4,107,733 +50%), with energy savings of \$349,680, carbon savings of 7,575 Tons eCO₂ annually (\$813/Ton), and maintenance savings estimated at \$87,850. The simple payback of this system based only on energy savings is 16 years, including maintenance savings the payback reduces to 13 years.

Option four is the exact same system, just larger scale. It involves the installation of 582 boreholes at 600' deep, and a horizontal piping system. The system is capable of producing 25,680 MBH of heating year round, totaling 224,950 mmBTU of heating energy annually. The capital cost investment is \$14,321,000 (\$9,547,350 + 50%) with energy savings of \$834,929, 15,126 Tons eCO₂ annually (\$947/Ton) and maintenance savings estimated at \$175,000. The payback of this system based only on energy savings is 15 years, including maintenance savings the payback reduces to 13 years.

2. INTRODUCTION

Morrison Hershfield Limited (MH) was retained by The University of Toronto (UofT) in May, 2018 to study the feasibility of a geothermal system installation located beneath King's College Circle at the St. George campus. The below represents the final draft report submission for review by the UofT.

2.1 Objectives

The main objective of this assessment is to study the feasibility of a geothermal installation beneath King's College Circle focusing on the relationship of installation parameters to cost benefit. Based on the evolution of received information from UofT four options provided that represent varying scales of geothermal systems and the benefits and drawbacks of each. This report is intended to provide key decision data and tools to assist the University to make an informed decision regarding the installation of a geothermal system.

2.2 Reference Documents

The following documents were provided for our review:

- Campus Site Plans (Heating, Cooling, etc.)
- Heat Trace Study - Michael Van Valkenburgh Associates (MVVA), October 19 2016
- 100% DD – Crossey Engineering Ltd., April 13 2018
- Geotechnical Engineering Report – Terraprobe Inc., September 14 2016
- Snow Melting Study Revision C – Crossey Engineering Ltd., June 1 2016
- Phase One Environmental Site Assessment – Terraprobe Inc., October 4 2016
- 2011 ASHRAE Handbook HVAC Applications – Chapter 34 “Geothermal Energy”, Chapter 51 “Snow Melting and Freeze Protection”
- The Economics of Geothermal Heat Pump Systems for Commercial and Institutional Buildings – R. Gordon BLOOMQUIST, November 2001
- Solar Heat Injection into Boreholes – Département de génie mécanique, École Polytechnique de Montréal
- RETScreen International, Clean Energy Project Analysis Third Edition – Natural Resources Canada

2.3 Limitations

Our assessment is based on the reference documents identified under Section 2.2. It is a basic assumption that any correspondence, material, data, evaluations and reports

furnished by others are free of latent deficiencies or inaccuracies, except for apparent variances discovered during the completion of this assessment. No performance testing was undertaken as a part of this assessment; rather, feedback provided by the on-site operations team together with our own calculations and analysis presented in the subsequent Sections of this report form the basis of all findings & recommendations presented under this assessment.

This report was prepared for the University of Toronto and should not be circulated or relied upon without our knowledge, and agreement from the University.

2.4 Opinions and Probable Cost

Opinions of probable cost noted in this report are Order of Magnitude Budgetary Estimates and provided only as an indication of the order of magnitude of the construction cost. They are based on recent costing data such as “Means Repair and Remodeling Cost Data”, discussions with equipment vendors and our professional judgment.

The capital costs estimated throughout this report are meant to be interpreted as total project costs. At the request of the University of Toronto, the following contingencies have been incorporated into capital costs;

- 15% Design Contingency to allow for unknowns at the feasibility stage (it is expected that by Issued for Construction, elements will be added to the design which will account for as much as a 15% cost increase).
- 5% Escalation Contingency to account for construction taking place in 2020.
- 10% Construction Contingency to allow for the inevitable unknowns of construction (it is expected that through construction of the systems, items will need to be addressed which will account for as much as a 10% cost increase).
- 20% soft costs to account for all internal and external soft costs to a project.

In total, 50% is being applied to all estimates to incorporate the above.

All costs are identified in 2018 Canadian dollars for work during regular business hours, not including any applicable taxes.

2.5 Methodology

For estimating the costs of the geothermal system multiple sources have been used in an effort to provide the most accurate results possible. Below is a summary of the unit rate values used to provide cost estimates (before applying 50% outlined in Section 2.4 above).

- Geothermal Boreholes have been estimated at **\$34/m** of vertical borehole, consistent to depths of 700’.
- The piping for the geothermal distribution has been estimated at **\$12/m** of pipe (increasing the cost of boreholes to \$58/m including U-bend pipes).

- The cost of the heat pump systems (including heat exchangers, pumps, electrical connection etc.) has been estimated at **\$125/MBH**.

Energy saving analysis that has been carried out throughout this report is a comparison of the existing University systems, and utility rates.

For the baseline heating system analysis, the steam system was reviewed. For the purposes of this report, we have assumed that the Steam Boilers have a burner efficiency of 86%, and that the Steam system has an efficiency of 90%.

For the baseline cooling system analysis, the chiller system was reviewed. For the purposes of this report, we have assumed that the chiller plant operates at a COP of 5.5 (0.64kW/Ton) at peak operation (100% load).

Utility rates for the purposes of this report will be **18¢/m³** Natural Gas, and **13.5¢/kWh** of electricity. It should be noted that Morrison Hershfield usually assumes 25¢/m³ Natural Gas, and 10¢/kWh of electricity, but due to the volatility of the market, the University of Toronto requested that its current annual landed rates be used.

To see a sample calculation of how these numbers are applied, if we have a geothermal system that produces 10,000 mmBTU of heat at a heat pump COP of 10, the following would be the results;

$$\text{Baseline Heating} = \frac{10,000 \text{ mmBTU}}{0.86 * 0.9} = 12,920 \text{ mmBTU} = 358,680 \text{ m}^3 \text{ Gas} = \$64,562$$

$$\text{Geothermal Heating} = \frac{10,000 \text{ mmBTU}}{10 \text{ (COP)}} = 1,000 \text{ mmBTU} = 293,071 \text{ kWh} = \$29,307$$

The energy cost saving of this heating system would be \$35,255.

For analyzing CO₂ emissions, we use data published in the 2015 EF from the National Inventory Report, 2017. This shows an emission factor of **0.043kg/kWh** for electricity, and **1.899 kg/m³** for Natural Gas. Both of these are in equivalent CO₂.

For estimating maintenance cost savings, published data from Bloomquist 2001 was used which showed that the average maintenance costs of a geothermal system were \$1.40/m²/year, compared to conventional HVAC system maintenance costs of \$3.60/m²/year. If we assume that the average building has a load of 30 btu/ft² (323btu/m²), we can get a unit rate of **\$6.81/MBH** of savings year over year.

For estimating costs of similar traditional systems, rudimentary values of **\$105/MBH** is used for heating systems, and **\$125/MBH** is used for cooling systems. This is before the 50% is applied.

In the systems we propose, we will be targeting a hot water supply temperature of 140°F in heating, and 42°F in cooling. Initially the University requested that we aim for 145°F in heating, but because the existing low temperature hot water loop is intended to run at 140°F, we are proposing to follow suit.

3. BACKGROUND ON GEOTHERMAL SYSTEMS

3.1 Geothermal System Operations and Installation

3.1.1 Geothermal Operations

Geothermal as a general concept is the process of using the earth to generate or store energy for use in either power generation or direct supply of energy. At the commercial and institutional level, the type of geothermal system that will be most commonly seen is a Geo-Exchange type system, which utilizes the thermal properties of the soil to store energy for later use.

The earth, at depths of around six meters or more becomes very consistent in its temperature. The seasonal effects of air temperature for traditional systems become greatly reduced, and temperature variances in geothermal systems become minimal year-round. This property of the temperature being shielded from the environmental conditions allows us to use the earth as a thermal 'battery' where we can dump, and extract heat as required to serve building HVAC needs.

3.1.1.1 Geothermal Balance

An important consideration to take into account throughout the operation of a geothermal system is the balance of the heating and cooling loads. Traditionally, geothermal systems are installed for use by a single building. Depending on the climate zone of the building, it may have heating dominant or cooling dominant HVAC loads. If the heating demand outweighs the cooling demand of the geothermal system, and heat is consistently extracted from the earth without a proportional amount of heat being returned, the average earth temperature will slowly drop over time.

Over a long enough time period, if the system remains unbalanced, the performance of the system can greatly decrease, to an extent where the geothermal field becomes unusable. To maintain a balanced and sustainable system, hybrid installations (further explored in section 5.2.2 & 5.2.3) are often proposed that involve some form of supplemental heating or cooling.

At the University of Toronto, a large benefit of the location is the access to large amounts of heating and cooling loads on campus. On a yearly basis, measurements can be taken, and the boreholes can be tested to ensure balance of the system.

3.1.1.2 Hybrid Geothermal Systems

Often times, the geothermal systems that are installed do not have an evenly balanced heating and cooling load. The solution to this problem is to supplement the geothermal system with an external heating or cooling source to artificially balance the system. If for example, your building is heating

dominant, a boiler would be installed, and operated in the winter months to either directly heat the building or to regenerate the geothermal field.

Hybrid systems can provide several benefits, from reducing the capital cost of the geothermal field, to increased efficiencies of the system. The benefits are further expanded upon when waste heat sources are available for use. Chiller condenser water, flue gas heat recovery, and even solar collection are all sources of hot water that can be used as the supplemental heating source for a hybrid geothermal system that don't have a production cost associated with them.

3.1.1.3 Heat Injected Geothermal Systems

A heat injected geothermal system is designed to store abundant heat recovered energy in the ground, to later distribute this energy to buildings with a heat load as needed. This type of energy storage is most suitable for heating systems that are designed within the approach temperatures between the charging mode / discharging mode and the ground storage mode.

3.1.2 Geothermal Systems

Under the umbrella of Geo-Exchange systems there are many different means of storing and extracting energy from the earth. To name a few, there is;

- **Vertical Ground-Coupled Heat Pumps:** This type of installation involves the vertical drilling of holes deep into the ground that are filled with loops of pipe with a U-bend at the bottom. A heat transfer fluid (usually a glycol water mixture) is pumped through the ground and back to a mechanical room, never leaving the system.
 - Vertical Ground-Coupled Heat Pumps are the most common type of installation in downtown Toronto. Although the initial cost is relatively higher, the benefits of a small overall footprint, and lower operation costs of a closed system drive the demand for this system.

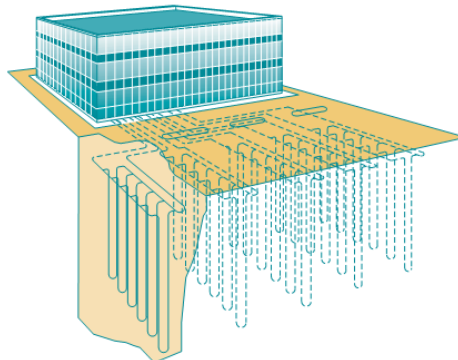

Figure 1 Vertical Ground-Coupled Heat Pump (RETScreen International, Clean Energy Project Analysis Third Edition – Natural Resources Canada)

- **Horizontal Ground-Coupled Heat Pumps:** This type of installation is very similar to its vertical counterpart, but instead of drilling holes deep into the ground, a large area is excavated, and the loops of pipes are installed in a horizontal arrangement. This type of a solution is more cost effective but requires very large amounts of land to get comparable system capacities to a vertical system.
 - Horizontal Ground-Coupled Heat Pumps are an attractive option due to their low capital cost investments but require very large fields of piping to be installed before appreciable thermal capacities are reached. Due to the real-estate limitation in downtown Toronto, this is not a reasonable solution for our application.

- **Surface Water Heat Pumps:** This type of installation is the least invasive and is relatively low cost. It involves the installation of a series of coiled pipes beneath a large body of water. A lake or pond is used as the heat exchanger in this case. Alternatively, the same system can be accomplished by pumping the lake or pond water, through heat exchangers within mechanical spaces to accomplish similar results (similar to the Enwave Deep Lake-Water Cooling System).
 - In our case, geographic constraints eliminate the opportunity to utilize a Surface Water Heat Pump system, all of these installations occur when the building is directly adjacent to a lake or river.

- **Ground Water Heat Pumps:** This type of installation involves the installation of well pumps drawing from a groundwater source. The ground water is continuously pumped into mechanical spaces, through heat exchangers, and then back into the ground. As opposed to Ground-Coupled Heat Pump systems, the ground water is part of an open loop, and freely mixes with the ground and soil.
 - Ground Water Heat Pumps were the first type of Geo-Exchange system to appear on the market but have fallen out of favour due to environmental regulations on ground water use, and the long-term instability of ground water systems (where temperature changes can occur).

For the application at the University of Toronto Campus, we will be exploring a Vertical Ground-Coupled Heat Pump system. This was chosen as the premier option due to its ability to get large thermal capacities out of a confined space, while increasing energy efficiency and reducing maintenance requirements. There are no specific permitting or environmental approvals for this system, as opposed to something like a water source heat pump system.

3.1.3 Geothermal Installation and Construction

Installation and construction of a Vertical Ground-Coupled Heat Pump system can be broken down into different construction phases. For the purposes of this report, we

will break down the construction into; **Vertical Installation, Horizontal Installation, and Mechanical Connection.**

The **Vertical Installation** involves the use of boring machines to drill 4” diameter boreholes down to a desired depth. After the desired depth is achieved, a pair of 1½” HPDE pipes, connected with a U-Bend at the bottom is inserted. To protect the pipe from the soil, and to increase the thermal transfer of the pipes, a grout is poured into the borehole. As the grout fills the borehole, the pipes are left protected, the soil is left protected, and any excavation fluids/materials are displaced to the surface for removal (refer to detail on MSK-1).

The Vertical Installation portion of the geothermal system construction is usually the most time consuming process. To avoid scheduling concerns, borehole installers have started to develop methods that allow for pre-drilling of the boreholes prior to site excavation. In short, the method involves drilling the holes, installing the grout and piping, and then cutting the pipe and putting a cap at a predetermined depth. Once excavation takes place, the boreholes are geo-located, the borehole caps are removed, and the horizontal connections take place.

The **Horizontal Installation** component of construction involves the header connection of all the individual boreholes in the geothermal field back to a central location. This work is completed after the site (or portion of site) has been excavated. A mini excavator is maneuvered around site, digging trenches just below the level of excavation to allow for the routing of the pipes. Once the pipes have been laid, the trenches are backfilled and left for the rest of construction to take place.

Finally, after the geothermal field has been installed (with vertical and horizontal piping) a connection is made back to a central mechanical room. The **Mechanical Connection** of a geothermal field to mechanical equipment is very similar to any standard mechanical chiller/boiler system construction. The geothermal field piping is routed back into the mechanical room where a series of headers complete with balancing valves are connected to pumps, heat exchangers, and heat pumps.

The finished result is a fully enclosed system, which leaves no visible components above grade. All of the equipment, and piping is either installed fully below grade, or within a mechanical room, and requires limited access from the surface level.

3.2 Existing Geothermal System Installations

As the price of energy increases over time, and the price of maintaining equipment increases overtime, the benefits of Geothermal systems are starting to outweigh the costs. Geothermal systems used to only be installed in remote locations where access to a heating source (either electric or fuel) was hard to come by, but now we see geothermal systems being installed across Canada, and in downtown Toronto.

The below are a few examples of geothermal systems, there are comparable to the system that is being proposed in this report.

University of Ontario Institute of Technology

The UOIT geothermal system is one of the largest of its kind, and when it was installed was the largest geothermal installation in North America. The geothermal system is a Vertical Ground-Coupled Heat Pump system that utilizes 384 boreholes installed at a depth of 700 feet. Similar to the system proposed here, it is used to heat and cool the surrounding campus buildings year-round.

Manitoba Hydro Place

Manitoba Hydro Place is a 22-story building, with a total of 65,000 square meters of office space with a geothermal system at the heart of the HVAC system. There is a total of 280 boreholes each 400 feet deep below the structure of the building, interspaced between the buildings foundation piles. The installation is a Vertical Ground-Coupled Heat Pump system and demonstrates the structural integrity of a geothermal system.

High Park Lofts

High Park Lofts at 433 Roncesvalles Ave is a 96 unit condominium that is heated and cooled by a geothermal Vertical Ground-Coupled Heat Pump system. This system utilizes 57 boreholes each 220 feet deep to provide the required building HVAC capacity. This project demonstrates the feasibility of a geothermal system in the downtown core of Toronto.

Drake Landing Solar Community

The Drake Landing Solar Community (DLSC) is a master planned neighbourhood in the Town of Okotoks, Alberta, Canada that has successfully integrated Canadian energy efficient technologies with a renewable, unlimited energy source - the sun.

The first of its kind in North America, DLSC is heated by a district system designed to store abundant solar energy underground during the summer months and distribute the energy to each home for space heating needs during winter months.

The system is unprecedented in the World, fulfilling ninety percent of each home's space heating requirements from solar energy and resulting in less dependency on limited fossil fuels.

The Government of Canada and its Canadian industry partners are proud to showcase Canadian solar thermal and energy efficient technologies in this one-of-a-kind community.

4. LANDSCAPE OF LANDMARK QUALITY PROJECT

4.1 University Site Background

The University of Toronto St. George Campus is located in the downtown heart of Toronto. The geothermal system that is proposed, and the area analyzed in this report is within King's College Circle (Front Campus).

It is known from studies associated with the parking garage structure installation that the site has a high ground water level, and that the prevailing water table level is at about 5.5m below grade. It should be noted that the existence of ground water has very little effect on the construction of geothermal systems. Boreholes can be installed from finished grade (before any major excavation works), and when installed use a grout solution to seal the hole, preventing any impact from ground water. Ground water and wet soil conditions actually have an increased benefit on geothermal systems, as the wet soils increase the thermal transfer rates of the earth.

There will be minor effects during construction of the high ground water level, but it is understood that the parking garage installation will have to excavate to a depth below that of the prevailing ground water, and will be draining the site. The expected impact of the high ground water level on the geothermal field is considered negligible due to the works already being completed by the Parking Garage Installation.

Corrosivity of the soil, as detailed in the Geotechnical Report provided to us shows standard levels consistent with that of a typical Toronto location, and will not have an effect on the performance or lifecycle of the geothermal system.

It should be noted that a geotechnical report only digs boreholes a fraction of the depth that geothermal systems are installed to. It will be required that test geothermal boreholes be drilled to provide a full and detailed analysis of the conditions. The results of these test boreholes will not have an effect on the findings of this report, but will rather provide information needed to produce a refined design.

4.2 Heat Trace Expansion Project

A major component of the Landscape of Landmark Quality Project at UofT is the large scale renovation and expansion of the ground heat trace systems around King's College Circle.

The latest information provided regarding the heat trace system was included within Crossey's 100% Design Development Drawing M-503. This drawing shows 2 heat trace zones which together total an area of 113,000 ft², and a peak heat consumption of 18,645 MBH.

4.2.1 Snow Melt Thermal Loads

Within the Crossey 100% DD, it is shown that the heat trace system will have 2 modes of operation, a "Melt Mode", and "Idle Mode". The approximate fluid

temperatures of the system are shown to be 140°F for the Melt Mode, and 104°F for the Idle Mode. Based on the information that the snow melt system is 113,000 ft² and 18,645 MBH, we can see that the snow melting system was designed for a peak capacity of 165 btu/hr/ft².

Based on information outlined in '*ASHRAE Handbook – HVAC Applications Chapter 51 (2015)*', we can use the peak capacity of 165 btu/hr/ft² to estimate the annual heating consumption. For the Melt Mode, we can estimate an annual consumption of the system to be 750 mmBTU. For the Idle Mode, we can estimate an annual consumption of the system to be 12,870 mmBTU.

In total, the heat trace system can be expected to consume 13,620 mmBTU of heat annually. In the latest design, this is accomplished with steam provided at 100 psi, heat exchanged to produce the water at the above noted supply temperatures.

4.2.2 Parking Garage Project

Another major component of the Landscape of Landmark Quality Project is the installation of a parking garage structure beneath the Front Campus in King's College Circle. The installation and construction of the parking garage structure is the major constraint for the installation of the proposed geothermal system. Once installed, the prime land that is beneath the parking garage will no longer be accessible. The parking garage has an overall footprint of 11,000 m² that we will no longer have access to, and the walkways limit the possibility of trenching for pipes.

Installation of Geothermal systems beneath future structures and parking garages is a very common occurrence, particularly in areas where real-estate is limited like downtown Toronto. The geothermal system has limited effect of the structural integrity of the building above. The footings and foundations of the structure can be avoided due to the spacing of the geothermal system, and in most cases, the geothermal field is completely below the footings of the structure.

It is understood that construction of the parking garage is scheduled to start in September of 2019, with construction planned to be ongoing to 2-3 years (ending September 2021/2022). Due to the common occurrence of geothermal systems installed beneath overhead structures, standard construction procedures have been developed that nearly eliminate schedule conflicts.

5. GEOTHERMAL AT UOFT

There are many advantages to installing a geothermal system, but in majority of installations, all of the operations and maintainability benefits are not taken advantage of. A campus style installation, like the one proposed as a part of this feasibility study, has the unique capability of taking advantage of all the benefits geothermal has to offer.

5.1 Benefits of Geothermal for Snow Melt

For the systems that are proposed as a part of this report, namely the heat trace system, geothermal has unique efficiency benefits. As discussed in section 4.2 of this report, heat trace systems operate under two conditions, 'Active' and 'Idle'. Idle operation of heat trace systems are the default operation mode of the system, being used for more than 90% of the system uptime. During this mode of operation, lower water temperatures are required, only to maintain the ground above freezing temperature. For a geothermal system this means that the heat pumps are not required to lift the temperature. The geothermal ground loop water can be pumped directly (or separated by heat exchanger if preferred) through the heat trace system, effectively heating the ground with a free source of energy.

This increase of efficiency on an already energy efficient system results in greatly reduced energy costs, and greatly reduced greenhouse gas emissions.

5.2 Proposed Geothermal Options

Geothermal systems are flexible in nature. How deep you drill, and how many holes you drill correlates directly with the capacity of the system, and the cost of the system. Throughout the different discussions with UofT, many different options have been proposed, with different goals, and different outcomes. Listed below are 3 different options which demonstrate the different possibilities geothermal systems have to offer, with varying sizes, and operations. Note that option 1 and 2 are included in the Appendix section, as they are not the focus of this report.

5.2.1 Option 3: High Temperature Hybrid System

The third option being proposed in this report can be referred to as the high temperature hybrid geothermal system. This type of system expands on the thermal storage capabilities of geothermal systems, while reducing the reliance on heat pumps.

The option achieves its efficiency by increasing the utilization rate of the system (more uptime results in a shorter payback), and also reduces the reliance on heat pumps by storing heat at a higher temperature, and directly feeding the ground source water into the low temperature hot water loop at 140°F.

The goals of this option are to:

- Maintain a high utilization rate, resulting in reduced payback.
- Increase ground storage temperature, to allow for reduced reliance on heat pumps, resulting in lower capital costs, and higher energy efficiencies.

- Maintain focus on heating to increase carbon footprint reductions.

5.2.1.1 Methodology

The major differentiating factor between this option, and previous options is the temperature at which the ground is being maintained. To increase the ground temperature, there will have to be some revisions to how waste heat is handled, and the supply of heat to the geothermal field. Where in previous options we supplemented the geothermal system with Return Sofame Water, and Chiller Condenser Water, in this option, we are proposing to make connection to the Sofame Supply Water Loop to further increase ground temperature.

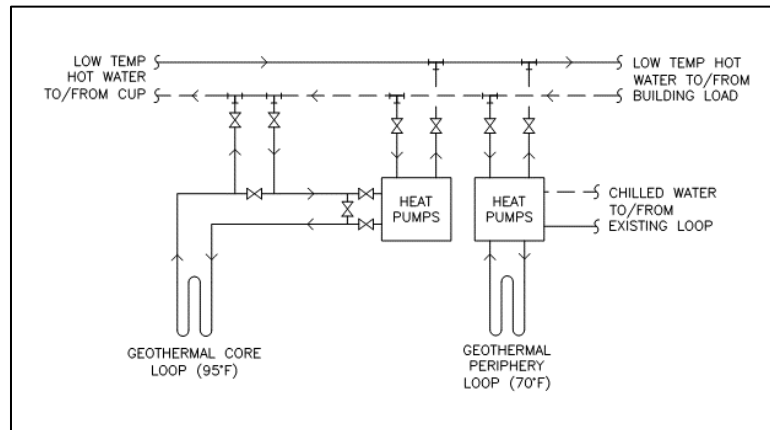

Figure A: Heat Injected From Sofame Return

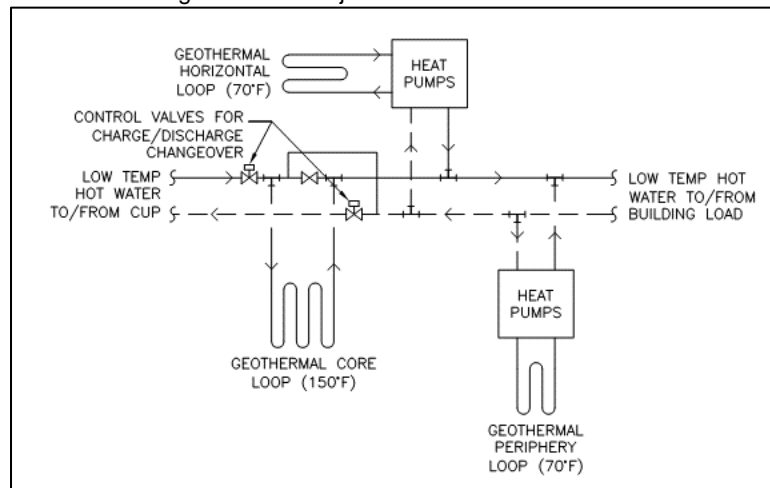
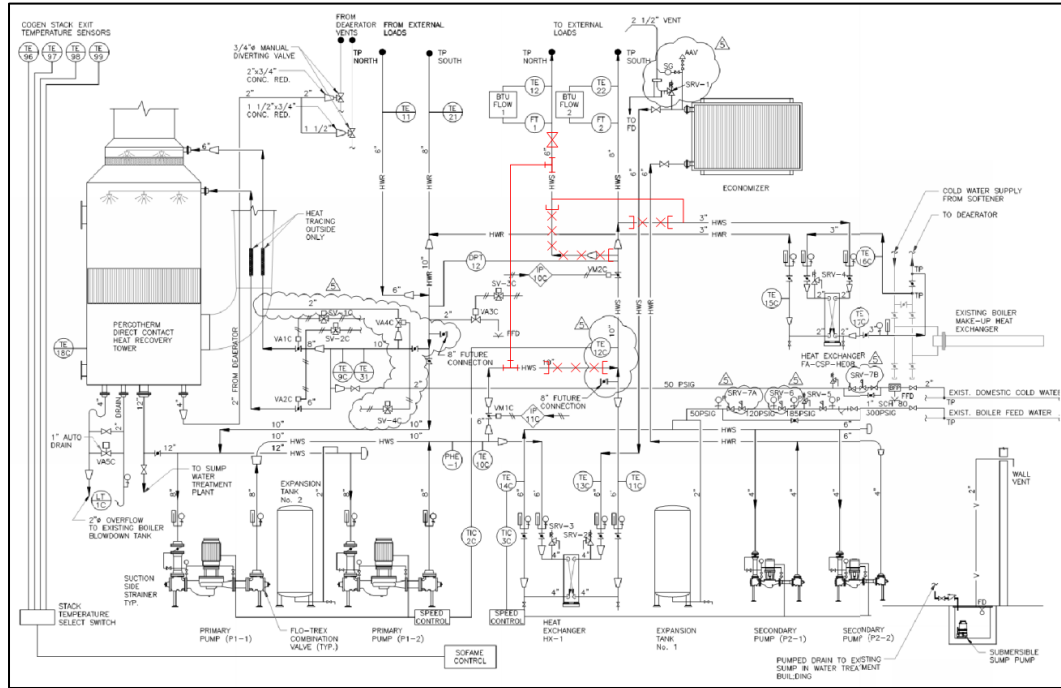

Figure B: Heating Injected From Sofame Supply

In the above two schematics, the first figure shows the system proposed in previous options with connections to the return of the low temperature hot water loop. The second figure shows a slightly modified system which makes connections to the supply and return of the low temperature hot water loop. Tying into the supply as opposed to the return allows us to maintain the Core geothermal borehole loop at a much higher temperature. This eliminates (for part of the system) the reliance on heat pumps, and greatly increases the efficiency of the system.

It should be noted that because we are now connecting to the supply of the low temperature hot water loop, we can no longer continuously extract heat from the system. The operation for this system will only extract heat from the loop when there is a reduction in demand, and spare capacity is available.

To maximize the thermal storage potential, we are also proposing minor modifications to the Flue Heat Recovery system to allow for direct feed of low temperature hot water to the geothermal system, without affecting the operation of the rest of the low temperature hot water loop. The below schematic represents the proposed changes to allow for the desired operation.



In the above, we can see that with some minor piping modifications, we can feed the geothermal system with hot water from the Flue Gas Heat Recovery system, without affecting the existing low temperature hot water loop. This also gives us the opportunity to extract heat at higher temperatures than the desired operation of the low temperature hot water loop. During periods of low system demand, and high exhaust, we can expect to be able to get hot water at temperatures up to 160°F, and maintain the system at the existing set point of 140°F. This will allow us to maintain the ground at a temperature of 150°F. With this increased ground temperature, there will have to be some alterations to the geothermal field.

5.2.1.2 Geothermal Connection

With the ground being maintained at 150°F, there are now three separate geothermal loops being proposed, a 4" Core loop (blue), Periphery loop (red), and Horizontal loop (green).

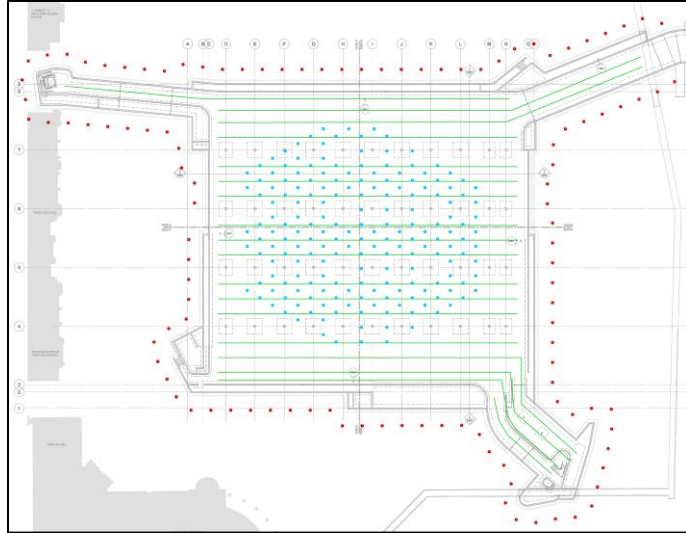

The Core loop functions similar to that proposed in Option 2 above. This is the area where the ground is maintained at a high temperature of 150°F. This set point was chosen to allow for the geothermal system to act directly as a heat exchanger, and provide hot water to the low temperature hot water loop directly at 140°F without the use of heat pumps.

The Periphery loop again is used here as a way of capturing the dissipation losses. Due to the higher temperature of the Core loop, the Periphery system is even more important than it was in Option 2 above. With a higher differential temperature of the core at 150°F and the neutral ground temperature at 55°F, the dissipation losses could be expected to be as great as 15% without the Periphery loop.

New to Option 3, is also a Horizontal loop that will be installed below the entire footprint of the excavated area of the parking garage. This piping loop is very similar to the Horizontal Ground Coupled geothermal system described in section 3.1.2 above. In short, instead of drilling boreholes down far below grade, the piping is laid just below grade, and just above the header connections for the Core/Periphery loops. The goal of this system is similar to the Periphery system, in that we are trying to trap the heat of the core system, and prevent it from bleeding upwards and unintentionally heating the Parking Garage or grade.

In total the geothermal system proposed will consist of 200 boreholes at 600' depth for the Core loop, 111 boreholes at 600' depth for the Periphery loop, and 30,000' of horizontally laid piping.

5.2.1.3 Mechanical Connection

The mechanical connection for this system will be slightly different than the one proposed in previous options. This system will have a higher ground temperature (at 150°F), and will therefore have a reduced reliance on the heat pumping system. Of the three geothermal loops, only the Periphery and Horizontal systems will use heat pumps, with the Core system directly feeding hot water to the low temperature hot water loop.

Another change in this system from previous options, is the revisions to the cooling supply. Due to the higher temperature of the Core system, there will be increased heat being transferred to the Periphery system that will have to be offset. The heat pumps for the Periphery loop will have to operate at a higher lift, to allow for the ground to regenerate sufficiently and allow for cooling. Note that in the analysis of this option, cooling has not been provided, this is an option that can be explored further at the request of the University of Toronto.

For the Core geothermal loop, the ground will be maintained at 150°F. There will be no heat pumps for this system, and the hot water will be directly supplied to the low temperature hot water loop at 140°F. Based on the number of boreholes, this system will be capable of producing a total of 7,200 MBH of heating, at no additional electrical costs.

For the Periphery geothermal loop, the ground will be maintained at 70°F. The heat pumps will lift this heat, and supply the low temperature hot water loop at 140°F, with a return of 110°F. This system will produce at total of 4,000 MBH of heating at an operating COP of 4.3.

For the Horizontal geothermal loop, the ground will be maintained at 70°F. The heat pumps will lift this heat, and supply the low temperature hot water loop at 140°F, with a return of 110°F. This system will produce at total of 1,700 MBH of heating at an operating COP of 4.3.

5.2.1.4 Results

The resulting system will be capable of producing 12,900 MBH of heating year round, totaling 113,000 mmBTU of energy (assuming 100% load all year). The capital cost investment of this option has been estimated at \$6,161,600.

Assuming a full buildout, the ongoing costs of this size of system has been estimated to have an annual energy savings of \$349,680 year over year. This energy saving assumes that the system is operated at 100% capacity, year round. The annual maintenance costs of the system have been estimated at a savings of \$87,850 year over year.

For a generic heating system (boilers) of equivalent capacity, it has been estimated that the capital cost investment would be \$1,612,500.

On the energy savings alone, this installation would have a payback of 16 years. If we include the maintenance cost savings, the payback can be reduced to 13 years. Lastly if we compare this type of system, to a similar installation, the payback can be estimated at 10 years. This system would reduce the existing university utility load by 4,053,047 m³ of natural gas, at the cost of increasing the electrical demand by 2,813,835 kWh. This converts to an annual CO₂ reduction of 7,575 Tons eCO₂ per year (at a cost of \$813/Ton of CO₂).

5.2.2 Option 4: High Temperature Hybrid Large Scale System

The fourth and final option being proposed in this report is very similar to option three above, but this time with an increased number of boreholes and some minor differences in borehole technology. This design has one third of the core boreholes upgraded to a 6" diameter borehole, with coaxial vertical pipes and passive turbulators. This type of borehole results in an improved approach temperature between system charging/discharging modes and the maintained ground temperature of 150°F. This type of system increases the thermal storage capabilities of the ground, and increases system efficiency without increasing the overall footprint of the geothermal field, but is more costly than traditional geothermal boreholes.

5.2.2.1 Methodology

The proposed methodology for option four is exactly the same as option 3 above. System operation and flow patterns will remain the same, only the size of the system has been changed.

5.2.2.2 Geothermal Connection

With the ground being maintained at 150°F, there are now five separate geothermal loops being proposed, a 6" Core loop (purple), a 4" Core loop (blue), an Intermediary loop (orange), Periphery loop (red), and Horizontal loop (green).

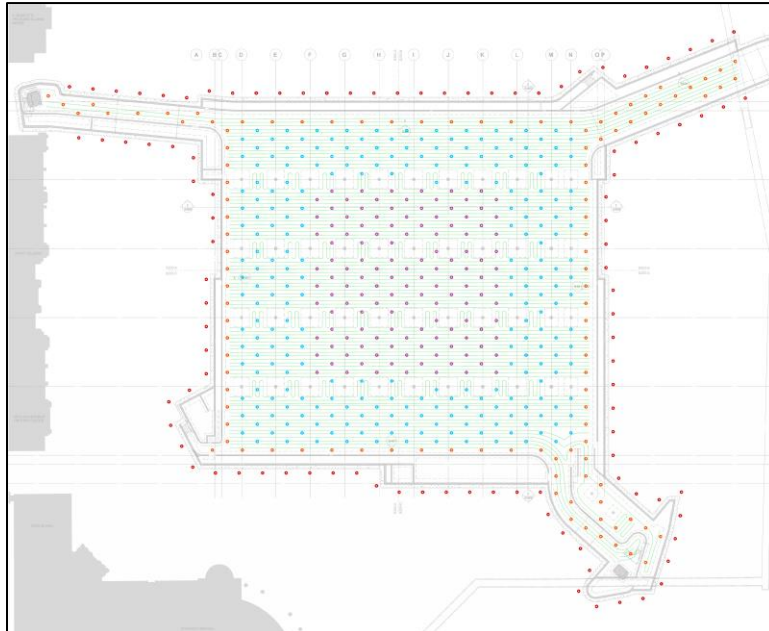

The Core loops functions similar to that proposed in Option 2 above. This is the area where the ground is maintained at a high temperature of 150°F. This set point was chosen to allow for the geothermal system to act directly as a heat exchanger, and

provide hot water to the low temperature hot water loop directly at 140°F without the use of heat pumps.

The Intermediary and Periphery loops are used here as a way of capturing the dissipation losses. Due to the higher temperature of the Core loops, the Intermediary and Periphery systems are even more important than it was in Option 2 above. With a higher differential temperature of the core at 150°F, a denser borehole arrangement than option 3 and the neutral ground temperature at 55°F, the dissipation losses could be expected to be as great as 20 % without the Intermediary and Periphery loops.

Similar to Option 3, is the Horizontal loop that will be installed below the entire footprint of the excavated area of the parking garage.

In total the geothermal system proposed will consist of 370 boreholes at 600' depth for the Core loops, 212 boreholes at 600' depth for the Intermediary and Periphery loops (total of 582 Boreholes), and 30,000' of horizontally laid piping.

5.2.2.3 Mechanical Connection

The mechanical connection for this system will be the same as the one proposed in option 3, just larger capacities due to the increase quantity of boreholes.

For the Core geothermal loop, the ground will be maintained at 150°F. There will be no heat pumps for this system, and the hot water will be directly supplied to the low temperature hot water loop at 140°F. Based on the number of boreholes, this system will be capable of producing a total of 16,400 MBH of heating, at no additional electrical costs.

For the Periphery geothermal loop, the ground will be maintained at 70°F. The heat pumps will lift this heat, and supply the low temperature hot water loop at 140°F, with a return of 110°F. This system will produce at total of 7,632 MBH of heating at an operating COP of 4.3.

For the Horizontal geothermal loop, the ground will be maintained at 70°F. The heat pumps will lift this heat, and supply the low temperature hot water loop at 140°F, with a return of 110°F. This system will produce at total of 1,700 MBH of heating at an operating COP of 4.3.

5.2.2.4 Results

The resulting system will be capable of producing 25,680 MBH of heating year round, totaling 224,950 mmBTU of energy (assuming 100% load all year). The capital cost investment of this option has been estimated at \$14,321,000 (\$9,547,350 + 50%).

Assuming a full buildout, the ongoing costs of this size of system has been estimated to have an annual energy savings of \$834,929 year over year. This energy saving assumes that the system is operated at 100% capacity, year round. The annual

maintenance costs of the system have been estimated at a savings of \$175,000 year over year.

On the energy savings, this installation would have a payback of 15 years. If we include the maintenance cost savings, the payback can be reduced to 13 years. This system would reduce the existing university utility load by 8,068,765 m³ of natural gas, at the cost of increasing the electrical demand by 4,573,693 kWh. This converts to an annual CO₂ reduction of 15,126 Tons eCO₂ per year (at a cost of \$947/Ton of CO₂).

6. ADDITIONAL INFORMATION

6.1 Next Steps and Design Coordination

The installation of a geothermal system below a parking garage will require moderate design coordination efforts between the designers of the geothermal system, and the designers of the parking garage. The effects of a geothermal field, will have to be coordinated with the Geotechnical and Structural engineers to ensure that there is no effect on the structural or civil integrity of the parking garage structure. Mechanical engineers will have to be coordinated with to confirm connection locations for both the geothermal field, and connection to existing site distribution. Electrical engineers will have to provide increased electrical feeder capacity to allow for operation of a heat pump system. Architects will need to provide access hatches in the parking garage, and mechanical space for the heat pump equipment.

Although there are all of these items, and more design coordination exercises to surface throughout design, it is our opinion that there is not a coordination effort too large to hinder the feasibility of a geothermal system installation. Considering the scale of the project, the total amount that the geothermal field, and heat pump system interfaces with the parking garage is relatively limited. For the purposes of this study, the costs of potential design conflict, and coordination efforts are considered to be included within the 15% design contingency, and 20% project contingency that are built into the overall costs estimates provided throughout this report.

The crucial next steps in progressing the design and coordination efforts are to get 3-4 test geothermal boreholes drilled to the proposed depth of 600' to confirm the conclusions of this report. It will also be critical for the geotechnical and structural engineers to review the impacts of the proposed geothermal field. This ideally will take place while the geothermal design team progresses from this feasibility stage, into a schematic design stage to confirm final system parameters.

6.2 High Lift Heat Pump Technologies

Over the past few years in the industry there have been large advancements in heat pump technologies that focus on providing large amounts of lift, such that you can now simultaneously provide heating and cooling at usable temperatures. The leading example of this is CO₂ chillers, which can provide 160°F hot water, while also producing 42°F chilled water.

In normal applications of these technologies, issues arise when trying to find buildings that require proportional amounts of both heating and cooling at the same time consistently. When applied to a geothermal system, or any other type of thermal storage system, you eliminate the need for simultaneous heating and cooling, and can just store the unused energy for a later time.

For the options proposed in this report, a high lift CO₂ heat pump would allow for the Periphery systems to be cooled much more dramatically, and increase the opportunity to produce chilled water. Should the University want to increase the chilled water capacity of the geothermal system, CO₂ heat pumps would be needed to maintain system to balance.

6.3 Phase Change Thermal Storage

Phase Change Thermal Storage is a relatively recent technology that operates similar to ice storage systems that have existed in the HVAC industry for years, but instead of produce ice at low temperatures, a phase change medium is used to store latent energy at temperatures from -50°F to 250°F. Chemically altered liquids are used which can have their freezing/melting points manipulated as required by the application to allow for latent storage of heat.

For the options provided above, a thermal storage tank can be used to supplement the geothermal system and allow for increased performance. The thermal storage tanks are provided with much more efficient heat exchange plates than the U-bend pipes provided in a geothermal system. This means that the temperature approach of the storage tanks can be much less than the temperature approach of the geothermal system. In roughly estimated figures, if the geothermal system is maintained at 150°F, it would have a supply at 160°F and a return at 140°F resulting in an approach of 20°F (160-140), where a phase change tank could be maintained at 145°F provided a supply of 150°F and returning the same desired 140°F water, resulting in an approach of 10°F (150-140). This smaller approach means that you can supply lower temperature water to the thermal storage system, and have the same result of 140°F water.

Ultimately, phase change thermal storage would have to be used in conjunction with a geothermal system, as the storage capacities of a geothermal system greatly outweigh those capable in phase change tanks, but could prove beneficial in helping reduce the waste heat supply temperature, while maintaining the system supply temperature.

6.4 Medical Sciences Building Heating Load

Through discussions with the University, it has been stated that the Medical Sciences Building (MSB) will be a likely candidate for the geothermal heating capacity. For a frame of reference, the peak heating demand of the existing Sofame system is 4,250 MBH, with an annual consumption of 11,522 mmBTU. Comparing to option 3 proposed above, MSB would represent 33% of the peak capacity, and 10% of the annual heating capacity. Payback calculations will largely be effected by the actual usage of the energy, and the calculations in our options assume best case scenario.

6.5 Connection to Existing Services

For all options outlined in Section 5 above connection to existing Site Services will have to be made. It is our understanding from information provided by the Parking Garage designers, a fair amount of coordination efforts will have to be completed before a proper distribution can be proposed. For the purposes of this report, and at the current stage of the design, there are two preliminary options.

The first is a connection to the proposed new service lines being installed within the parking garage. As part of the parking garage design, new campus service lines are being routed from their existing buried location, to a more accessible access chase in the parking garage. Connection to site services at this location is the most cost effective approach, and will have

the easiest installation, but will require coordination within the current parking garage design. The cost of this option has been carried in all proposed solutions.

A secondary option, should the connection in the parking garage be deemed not feasible, is a connection to existing site services through installation of new buried piping in a service tunnel. New connections can be made to the existing buried Sofame Hot Water Line south of King's College Circle. Drawings show that the existing Sofame lines are 8" in diameter which is sufficient to support the geothermal options included within this report. The costs of installation a new service tunnel, or buried pipes for connection to existing site services has not been included within this report.

7. CONCLUSION

Based on the above information, it is clear to us that the leading option is option number 4 above described in section 5.2.2. We highly recommend that the University of Toronto consider this option as the preferred option when taking the next steps.

The immediate recommended next step is to determine the project schedule of the underground Parking Garage project, coordinate as required, and make modifications to the geothermal system as needed to maintain construction schedule and reduce impacts as much as possible. Coordination with the geotechnical, structural, and mechanical engineers of the proposed underground garage will be required to take place to confirm that the parking garage and geothermal systems are integrated properly.

Following coordination with the Parking Garage project, the recommended next step is to identify the maximum available heating load that can be connected to this proposed geothermal system within the near future. It is our understanding that the Medical Sciences Building and Landmark Snow Melting system are the initial heating load that may be connected to the proposed geothermal system. The geothermal system proposed in option 4 has the potential to serve over 8 times of this initial load. The project scope, cost, and payback will be adjusted to suit both initial and final loads that can be connected, as well as available construction cost to the project.

When the scope and scale of the final geothermal installation is confirmed, a more detailed schematic design can be completed which includes required modifications to the Sofame system, detailed connection to existing site services, monitoring of existing systems to confirm performance, and modeling/testing of the geothermal system. A computerized simulation with the support of a University of Toronto PhD professor is highly recommended to help determine the exact parameters that should be used to operate the system most efficiently. These simulations will require the results of geothermal test boreholes that are dug on site, to provide accurate inputs.

All of this information we recommend should be included within the next stage of the project, during a complete schematic design process.

We trust that the solutions proposed in this report provides the University of Toronto with the tools required to make an informed decision as it relates to the next steps in installing a Geothermal System and the University Campus. We remain available to consult with the University team with regards to any contents of this report. In the interim if you have any questions relating to any portion of this report, please do not hesitate to contact any of the undersigned.

Very truly yours,
Morrison Hershfield Limited



Peter Robinson, EIT,
Mechanical Designer,
Buildings Facilities Engineering

Rino Zan, P.Eng.
Principal, Commissioning
Department Manager



Wassim Faraj, P.Eng.
Principal & Director,
Building Technical & P3 Specialist

APPENDIX A: Drawings

UNIVERSITY OF TORONTO
 GEOTHERMAL FEASIBILITY
 FLUE GAS HEAT RECOVERY SYSTEM
 PROPOSED PIPING REVISIONS

Drawing No.:

MSK-2

Project No.:	Date:		Suite 300 - 125 Commerce Valley Drive West Markham, ON L3T-7W4 Tel: (416) 499-3110 Fax: (416) 499-9658
1803671	SEPT 2018		
Drawn: PR	Design: PR	Checked.: WF	Dwg. File:

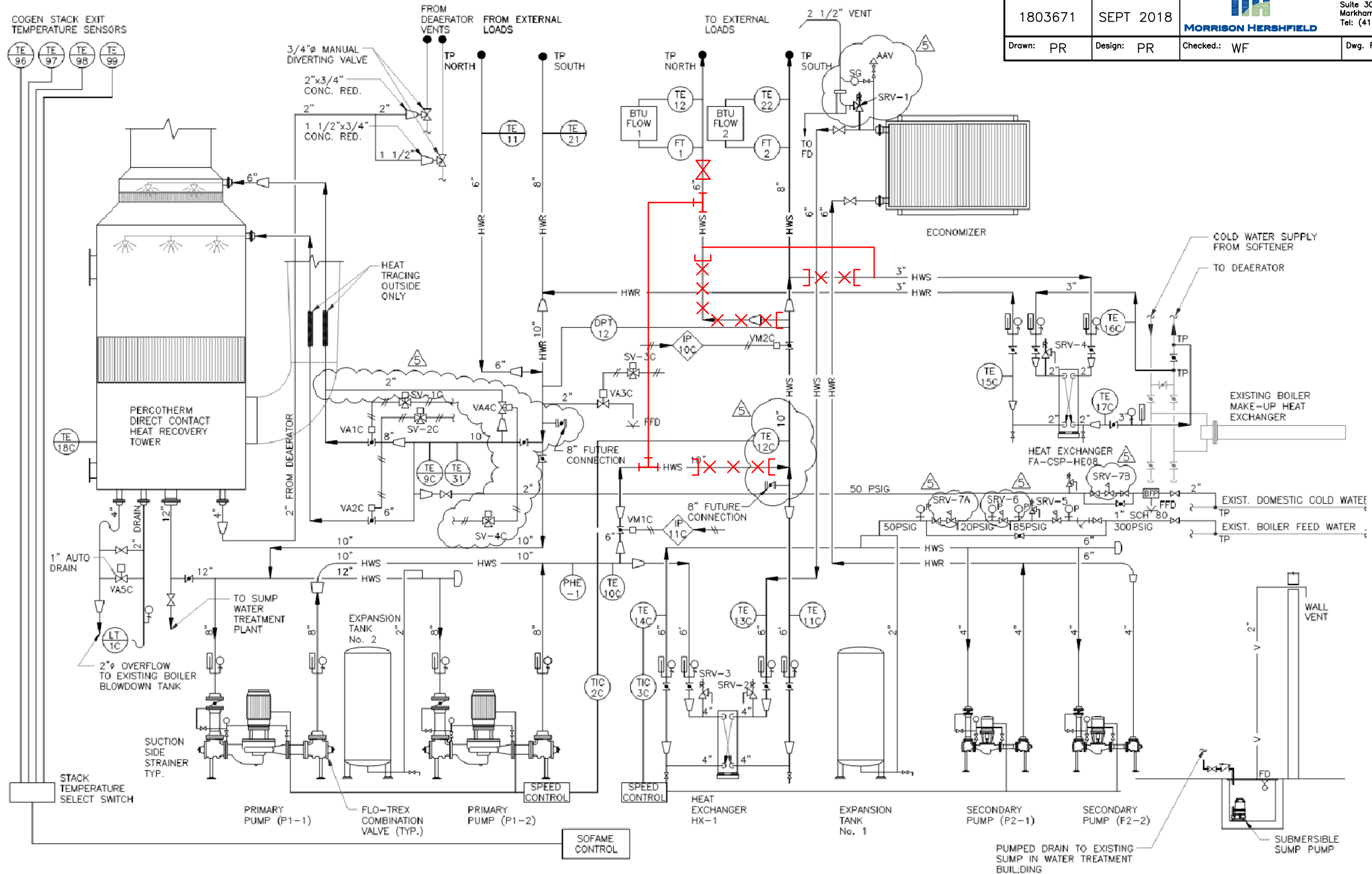

Filename: P:\2018\180367100-Landscape of Landmark Quality-Geoth\08_CAD\07_Sheets\Schematics.dwg
 Plotted: September 12, 2018 by: Peter Robinson

APPENDIX B: Preliminary Proposed Options

7.1.2 Option 1: Balanced Heating and Cooling Geothermal System

The first option proposed is a balanced geothermal system that produces equal amounts of heating and cooling energy. This system uses the storage capabilities of the earth to store heat from the summer for use in the winter and vice-versa. Heat pumps are used to lift the moderate ground temperatures to higher grade temperatures for use in heating and cooling applications.

Three different options were proposed in detail in Morrison Hershfield’s earlier report dated June 21st 2018. In that report three different variations were proposed to demonstrate the effect of borehole depth and quantity on capital cost and capacity.

Quantity of boreholes	Depth	Capital Cost	Construction Length	Energy Extracted
586	250'	\$5,582,674	10 Weeks at 12 Holes Per Day*	735 Tons Cooling 8,820 MBH Heating 4,432 mmBTU Annual
894	400'	\$13,722,481	22 Weeks at 8 Holes Per Day*	1,835 Tons Cooling 22,025 MBH Heating 11,100 mmBTU Annual
894	500'	\$17,016,217	22 Weeks at 8 Holes Per Day*	2,235 Tons Cooling 26,820 MBH Heating 13,000 mmBTU

* Construction timeline assumes 9-5 workday, 5 days a week, with 6 boring machines. With appropriate lead time provided, contractors can allow for more boring machines on site, decreasing overall project schedule.

To highlight the cost benefit of this type of system, the third variation listed above (894 holes at 500’ deep) will be further explored. A system of this size was chosen to maximize the amount of boreholes possible, which would still remain beneath the footprint of the Front Campus Field. The depth was chosen to remain within the constructability sweet spot for boreholes (at a depth of 700’ you begin to hit hard rocky shale layers resulting in increased drill time).

The resulting system is capable of 2,235 Tons of cooling in the summer months, and 26,820 MBH of heating in the winter months, totaling 13,000 mmBTU of annualized heating and cooling production (combined), at an assumed operational run time of 4,300 hours per year (or 970 equivalent full load hours). The capital cost investment of this option, has been estimated at **\$17,016,217**.

Assuming a full buildout, the ongoing costs of this size of system has been estimated to have an annual energy saving of **\$48,850** year over year. This energy saving assumes that the geothermal system uses the heat pumps for 20% of the year, and for 80% of the year the ground water can be used for the snow melting system directly. The annual maintenance costs of the system have been estimated at savings of **\$182,644** year over year.

For a generic heating and cooling system (chiller and boilers) of equivalent capacity, it has been estimated that the capital cost investment would be **\$5,877,900**.

On the energy savings alone, this installation would have a payback of 100+ years. If we include the maintenance cost savings, the payback can be reduced to 46 years. Lastly if we compare this type of system, to a similar installation, the payback can be estimated at 35 years. This system would reduce the existing university load by 233,000 m³ of natural gas annually, and 51,000 kWh of electricity. This converts to an annual CO₂ reduction of 445 Tons eCO₂ per year.

7.1.3 Option 2: Low Temperature Hybrid System

The second option being proposed can be referred to as the low temperature hybrid geothermal system. This type of system is attempting to increase the run time of the geothermal system to increase the operational cost savings, while maintaining a similar capital cost.

The goals of this option are to:

- Increase utilization rate of the system, resulting in reduced payback.
- Maintain similar capital cost to option 1 above.
- Focus on providing more heating energy, increasing carbon footprint reductions.

7.1.3.1 Methodology

To achieve higher run times, we needed a load that is consistent throughout the year. Below are estimates of the University Heating and Cooling loads over a year.

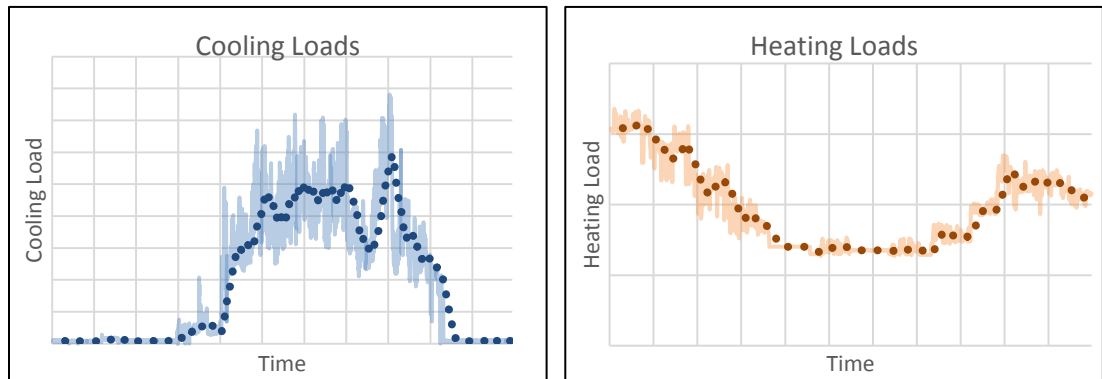

From the above, we can see that during the winter months, there is almost no cooling load on the University Campus. In contrast, the heating load at the University is much more consistent year round. The existence of high energy usage lab spaces, which use reheat coils throughout the summer months, maintains a steady heating load year round. This heating load is the prime candidate to allow us to use the geothermal system year-round, 24/7, increasing the utilization rate of the system, thereby decreasing the payback.

To achieve a heating dominant geothermal operation a hybrid type geothermal system will have to be selected. To briefly summarize hybrid geothermal systems (further detailed in section 3.1.1.2 above) we will be supplementing the ground with additional heat, to balance the disproportionate amount of heat that we will be extracting. Traditional hybrid systems utilize a boiler to offset the imbalance, but due

to the unique opportunities available to the university, we will be utilizing campus waste heat to supplement the hybrid system.

7.1.3.2 Waste Heat Availability

There are two major sources of waste heat available to the University on campus; the **Return Sofame Water**, and **Chiller Condenser Water**. The Return Sofame Water is available at a range of 80°F to 110°F depending on the efficiency of the system, and the usage of the system. It should be noted that currently the Sofame system only operates at return water temperatures above 100°F due to the inability of condensing in the system, but there are plans to reduce this as much as possible with the addition of a stainless steel exhaust stack to allow condensing. The second source of waste heat is Chiller Condenser Water. During the summer months, instead of routing the 95°F condenser water to cooling towers, it can instead be injected into the geothermal system as needed. Below, the two different profiles can be seen for the waste heat capabilities of the Return Sofame Water system, and the Chiller Condenser Water system.

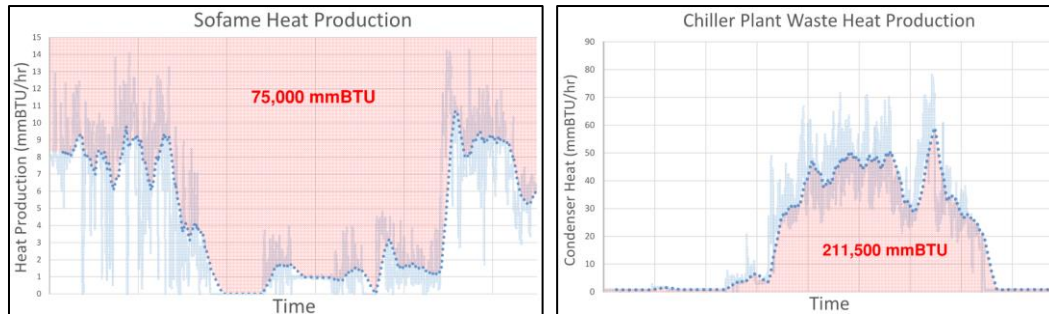

Left Figure showing Sofame System load in blue, and spare capacity highlighted in red. Right Figure showing Chiller Condenser System load in blue, with total capacity highlighted in red

From the above, we can see that if we take the spare capacity of the Sofame system, we have 75,000 mmBTU of annual energy that can be used, and if we take the load of the condenser water system, we have 211,500 mmBTU of annual energy that can be used. It should be noted that although the condenser water system produces more energy annually, it produces a lower grade of heat than the Sofame system (110°F vs 95°F). This means that although there is more energy, the energy is less usable.

7.1.3.1 Geothermal Connection

To store all of this low-cost waste heat, a geothermal field is being proposed with a total of 748 boreholes at a depth of 600'. These parameters were selected to maximize the thermal energy capabilities of the area directly beneath the proposed Parking Garage. Further to a standard geothermal arrangement, the system proposed for Option 2 separates the geothermal field into 2 different geothermal loops, the Core loop, and Periphery loop.

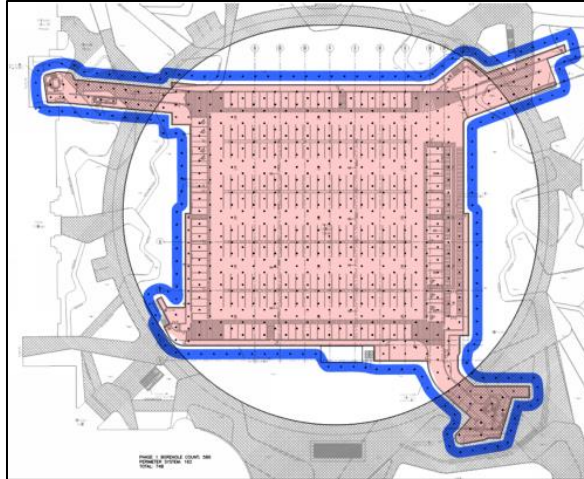

The above figure shows the Core Geothermal Loop highlighted in red, and the Periphery Geothermal Loop highlighted in blue.

The purpose behind these different loops, is to allow us to maintain a large majority of the ground at a higher temperature, without suffering dissipation losses. For the purposes of this option, we have selected to maintain the ground at a temperature of 95°F. This value was selected to work within the waste heat sources available (Sofame return at 110-80°F), and to increase the efficiency of the heat pumps as much as possible. If the entirety of the field were to be maintained at 95°F, you would start to experience dissipation losses around the perimeter of the field. The high temperature ground would slowly start to ‘bleed’ outwards into the surrounding ground due to the high ΔT of the 95°F ground in comparison to the neutral ground temperature of 55°F.

To capture these losses, a Periphery geothermal loop is being proposed which will be maintained at a lower temperature of 70°F and will be used for both heating and cooling to eliminate the dissipation losses. This periphery system would function much the same as a normal geothermal system, producing heating in the winter, and cooling in the summer. A focus of the operation will be to ensure that heating and cooling loads are balanced such that the periphery loop is consistently cooled on average, maintaining the target 70°F annual average.

7.1.3.2 Mechanical Connection

Connected to the 748-borehole geothermal field, will be a heat pump system similar to that proposed in Option 1 above. Aside from the increased utilization rate that these heat pumps will have, they will also be operating at a higher efficiency due to the increased ground temperature. By raising the ground temperature, we reduce the amount of work the heat pump has to do to lift the temperature up to a usable 140°F.

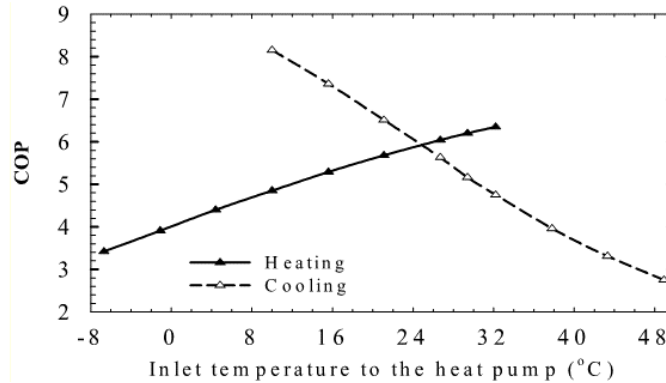

The above figure demonstrates the relationship between heat pump efficiency (or COP) and heat pump inlet temperature.

For the Core geothermal loop, the ground will be maintained at 95°F. The heat pumps will lift this heat, and supply the low temperature hot water loop at 140°F, with a return of 110°F. This system will produce a total of 21,000 MBH of heating at an operating COP of 5.2.

For the Periphery geothermal loop, the ground will be maintained at 70°F, and have two different operations for heating and cooling. In heating operation the heat pumps will lift the ground water, and supply the low temperature hot water loop at 140°F, with a return of 110°F. In heating, the system will be able to produce a total of 5,820 MBH of heating at an operating COP of 4.3. In cooling operation, the heat pump system will supply 52°F with a return of 42°F on the chilled water side. In cooling, the system will be able to produce 485 Tons of cooling at an operating COP of 5.3.

7.1.3.3 Results

The resulting system is capable of 21,000 MBH of heating year round, and 450 Tons of cooling in the summer months, totaling 183,960 mmBTU of heating energy, and 51,100 mmBTU of cooling energy, at an assumed operational run time of 8,760 hours per year. The capital cost investment of this option has been estimated at **\$16,983,100**.

Through discussions with UofT it was discovered that this type of system that relies heavily on heating production, through use of heat pumps is not cost effective from a payback perspective. At the initially assumed utility rates of 10¢ for electricity and 25¢ for gas, with a system efficiency of 56% low paybacks were achievable. After revising assumption to 13.5¢ for electricity and 18¢ for gas, with a system efficiency of 90% payback is not obtainable.

This system would reduce the existing university utility load by 6,598,317 m³ of natural gas, at the cost of increasing the electrical demand by 13,033,994 kWh. This converts to an annual CO₂ reduction of 11,970 Tons eCO₂ per year.

J. ROBERT S. PRICHARD ALUMNI HOUSE

KNOX COLLEGE

NONA MACDONALD VISITORS CENTRE

SIMCOE HALL

CONVOCATION HALL

EXISTING CURB AT EDGE OF LAWN

UTILITY REROUTING / FUTURE PROOFING MECH. EXHAUST RM

NW STAIR (SHARED ACCESS)

NE STAIR (SHARED ACCESS)

BIKE RAMP

VEHICULAR RAMP

ENTRY RAMP (SHARED ACCESS)

MECH. EXHAUST RM

GARAGE ELEC. & IT

PARKING GARAGE

GEO THERMAL

UTILITY REROUTING

MECH. INTAKE RM
GARAGE ELEC. & IT

GARAGE INTAKE SHAFT

SNOW MELTING EQUIPMENT

SW STAIR (SHARED ACCESS)

CISTERN & GROUNDWATER TREATMENT EQUIPMENT
GEO THERMAL ELECTRICAL SPACE
GARAGE ELECTRICAL SPACE

GARAGE INTAKE SHAFT
WALKWAY (SHARED ACCESS)

SOUTH PAVILION (EXCLUDED FROM CALCS)

EXISTING CURB AT EDGE OF LAWN

GERSTEIN SCIENCE INFORMATION CENTRE IN THE SIGMUND SAMUEL LIBRARY BUILDING

MEDICAL SCIENCES BUILDING

MEDICAL SCIENCES BUILDING

